

Altano



CARACTERÍSTICAS TÉCNICAS

ESTRUCTURA

Madera de pino macizo recubierto de poliuretano de varios grosores y densidades.

ASIENTO

Tipo sandiwich con bloque central de goma de 32 kgs. de densidad (Vefer).
Funda 100% microfibra Triafill.
Tejido Power Loom de Algodón.

DESENFUNDABLE

Asientos y respaldos.

RESPALDOS

Respaldos compartimentados rellenos de fibra 100% Dofill Plus fina y suave Tejido Power Loom de algodón.

PATAS

Metálicas níquel negro o negro mate en dos alturas distintas.

ACABADOS OPCIONALES



Pata níquel negro
(16 cms. altura)



Pata metálica mate
(15 cms. altura)



Pata metálica mate
(13,5 cms. altura)

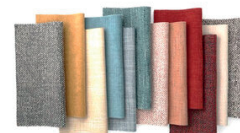

Tapizado en tela

Altano

DIMENSIONES

ALTURAS

Dimensiones en función a las distintas patas disponibles.

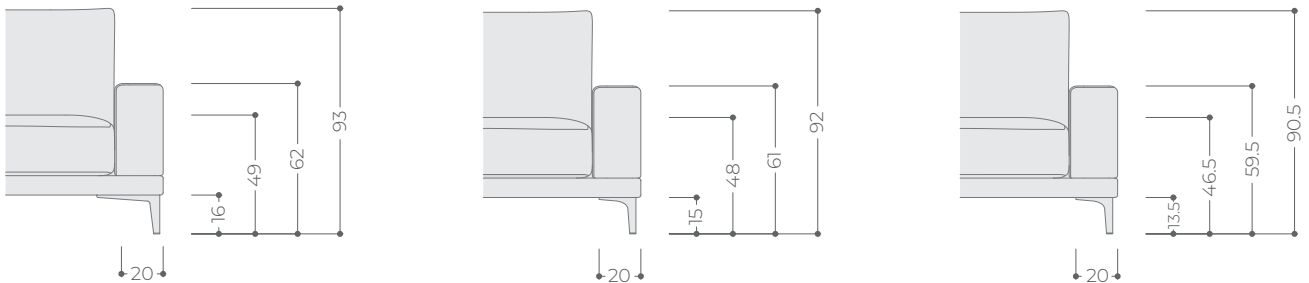

SOFÁS Y MÓDULOS

SOFÁ CON 2 BRAZOS

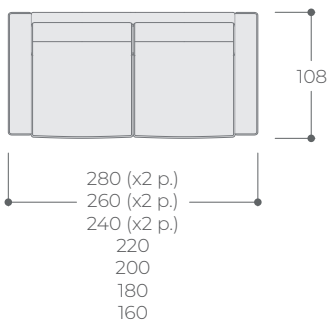

SOFÁ CON 1 BRAZO

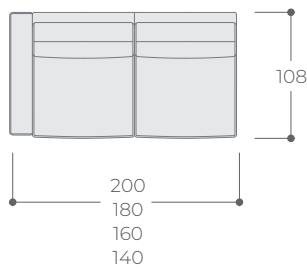

SOFÁ SIN BRAZOS

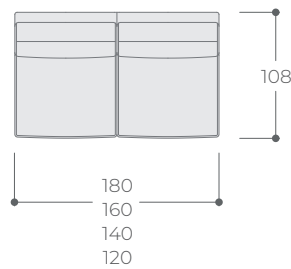

BUTACA

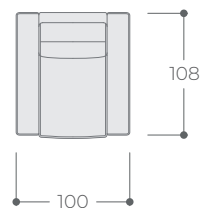

MÓDULO CON 1 BRAZO

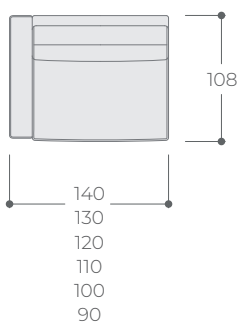

MÓDULO SIN BRAZOS

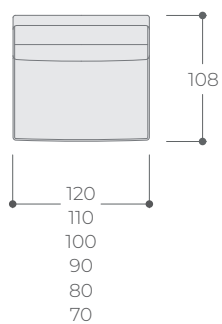

CHAISE LONGUE

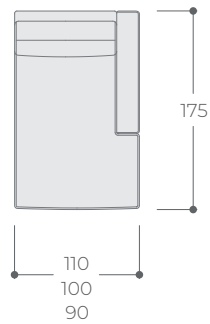

RINCÓN TERMINAL

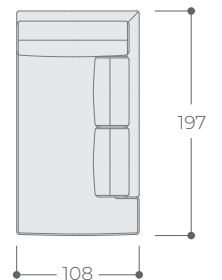

RINCÓN CERRADO

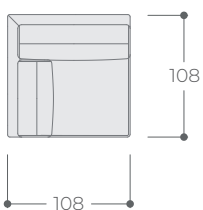

TERMINAL

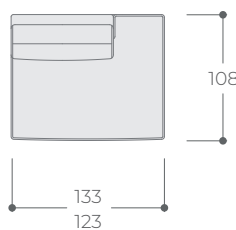

TERMINAL DOBLE

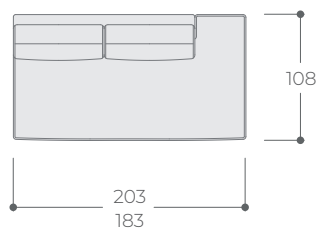

ANGULAR

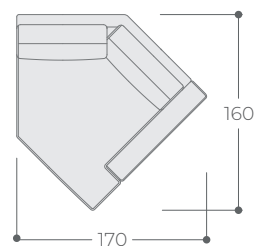

REPOSAPIÉS

